

CITIZEN

Cincom

A20

Sliding Headstock Type CNC Automatic Lathe



The Citizen A20, an evolving 5-Axis CNC sliding head machine, furthers the quest for cost and performance featuring the ability to switch between guide bush and non-guide bush types.

Acclaimed for its excellent cost to performance ratio, the A20 has evolved as a 5-axis machine for 20 mm diameter applications with the advantage that it can be used with or without a guide bush. It can be used as a regular guide bush automatic lathe when machining long slender workpieces, and without a guide bush for shorter parts with minimal bar end remnants. The guide bush can be quickly and simply mounted and removed.

The performance of the machine has been improved too. The high speed 10,000 rpm spindle enables optimised machining operations on smaller diameter bar material. The machining length per chucking is now extended to 200 mm enabling the number of re-chuckings and therefore cycle times to be reduced when machining long workpieces. As an option, bar material of up to 25 mm diameter can also be machined extending the range of workpieces.



Tooling System

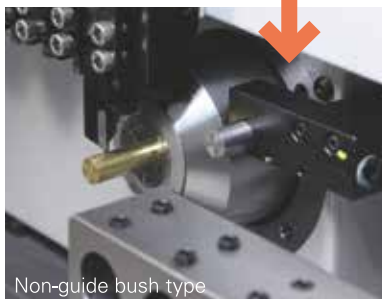
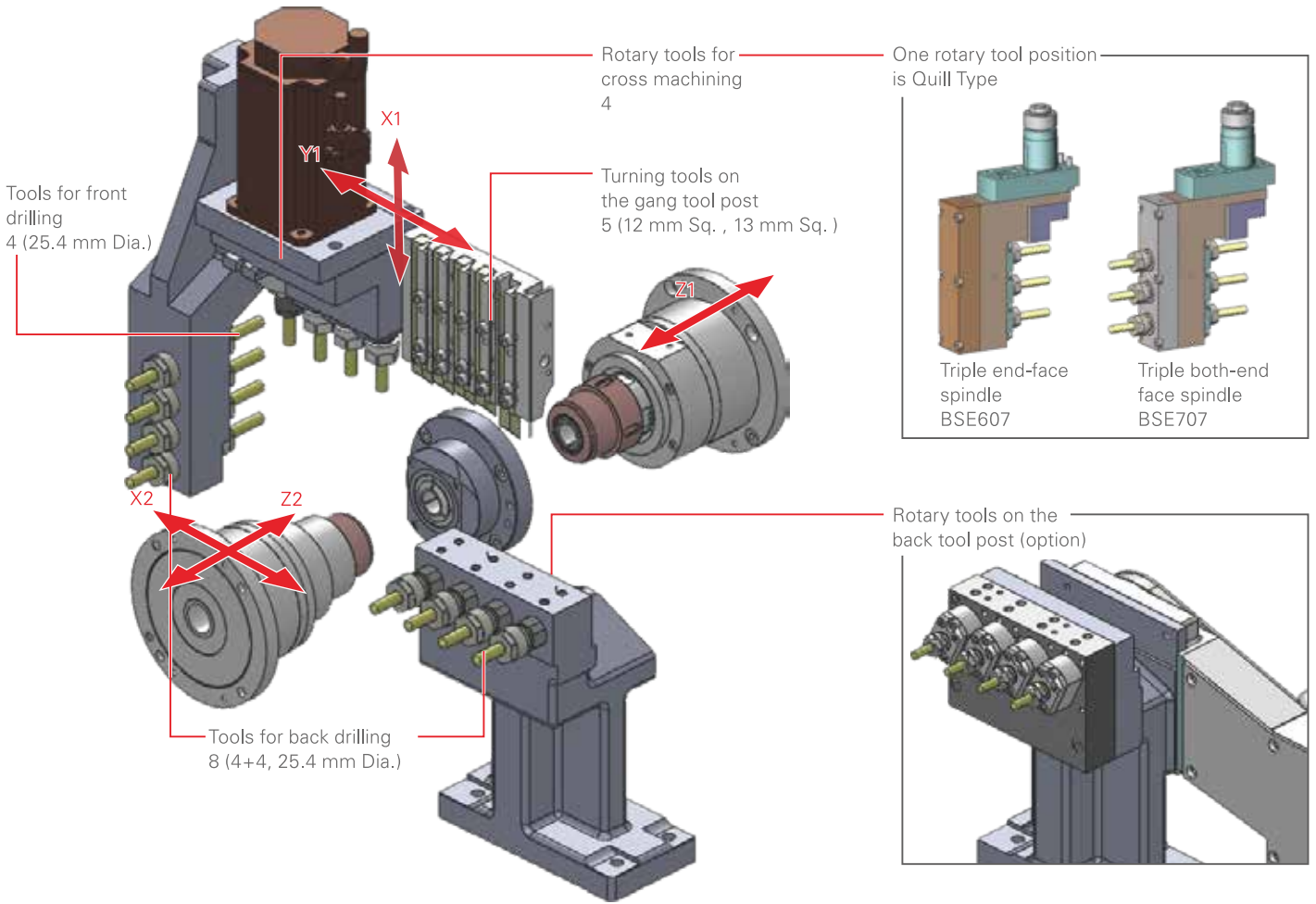

Switchable



LFV technology



LFV* is a technology for performing machining while vibrating the X and Z servo axes in the cutting direction in synchrony with the rotation of the spindle. It lessens the various problems caused by chips entangling with the product or tool, and is effective for small-diameter deep hole machining and the machining of difficult-to-cut materials.

*LFV is a registered trademark of Citizen Watch Co., Ltd. *Only LFV mode 1 available for A20.

Vibration mode

Item	LFV mode 1
Operation	Multiple vibrations per spindle revolution
Specification	The axes execute multiple vibrations during one spindle revolution, reliably breaking chips up into small pieces.
Application	Ideal for outer/inner diameter machining and groove machining
Waveform	

Comparison of chips

Material: SUS304 Weight: 14.3 g (same scale)



Chips generated by cutting using LFV



Chips generated by customary cutting

Variety of Machinable Geometries

Vibration cutting can handle a variety of types of machining in addition to linear machining on faces, including tapers, arcs, and drilling. Vibration cutting can be turned ON and OFF just by inserting G codes into a program, giving relief from chip entanglement and problems with the tool nose, depending on the material being machined.

Horizontal face

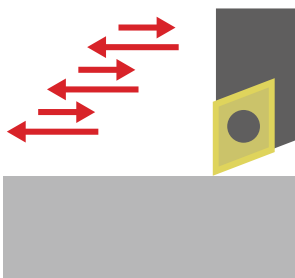

Vertical face

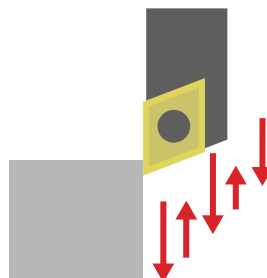

Taper

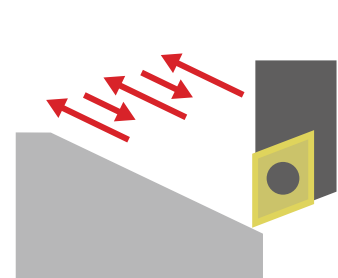

Arc

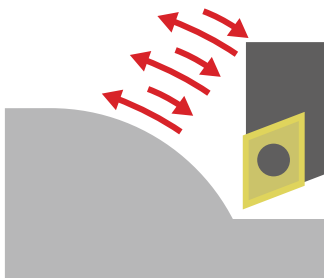

Drilling

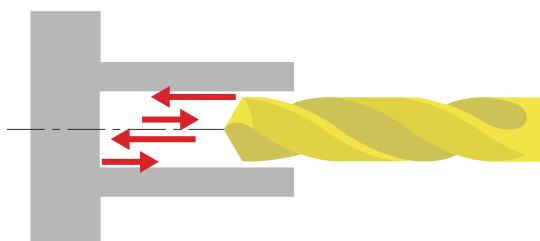

Along with machine performance, usability has also been upgraded.

More speed, more stroke, more capacity = improved productivity.

The A20 features a new capability to switch between guide bush and non-guide bush operating modes. The machine's performance, including spindle speed and machining length per chucking, has been increased. It is designed for ease of use and convenience with good chip clearance for fast set-ups.

Maximum spindle speed of 10,000 rpm.

The maximum speed of the front spindle is high at 10,000 rpm enabling optimized machining conditions on small diameter bar material or using small diameter cutting tools.

200 mm/ 1 chucking

A longer 200 mm machining stroke reduces the need for re-chucking workpieces hence reducing cycle time.

Support for stock material up to 25 mm diameter ^(option)

With its spindle through hole diameter of 26 mm, the A20 is capable of machining bar stock up to 25 mm dia. by installing the optional 25 mm size chuck device – enabling a wider range of workpieces to be produced over the standard 20mm machine.



Coolant nozzle

Coolant nozzles are provided at the appropriate locations to ensure that sufficient coolant can be supplied to the point of machining.



Parts collection

The large collection box reduces the frequency of emptying. The optional workpiece conveyor discharges to the left front of the machine.



Work light

Low energy illumination is provided as standard in the machining area giving an environment that is bright with ideal visibility.



Coolant tank/chip collection box

A 150-litre coolant tank is standard, enabling extended periods of operation. The chip outlet port has been increased to improve chip removal. Optional chip conveyors are available to suit the type of chip material.



Adjustable operation panel

The pivoting operation panel enables easy operation whilst simultaneously viewing the machining process.



USB/PC card slot

NC programs can be input and output using the USB slot or PC card slot on the front face of the control panel.

Clear for Anyone

Screen Display is Easy to View and Read



On-machine program check function
Using manual hand feed, operations can be run in the forward or reverse directions, can be paused to edit the program, and restart.



Display of code list
The function displays the list of G, M, and T codes including explanations-useful aid to programming.

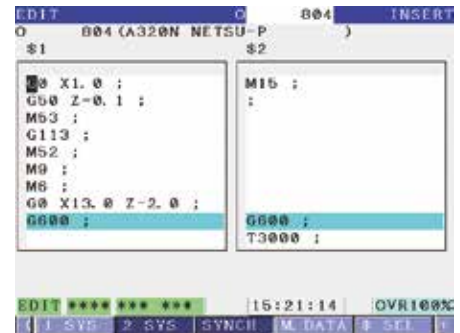

Easy viewing with text size change
Two text size settings can be applied to each screen (large text display illustrated).

Productivity Improvements

Idle time is slashed using the pre-processing function in the 'Cincom Control' that analyses the machining program before it is run to minimise processing and calculation times.

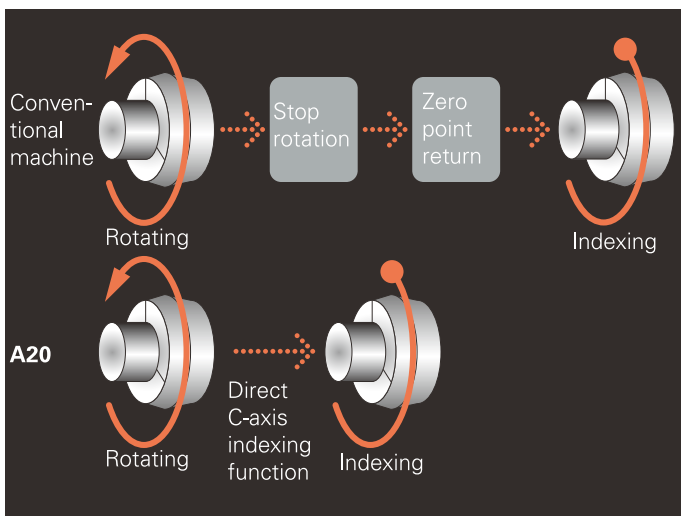

Direct C-axis indexing function
Direct C-axis indexing enables deceleration direct to chosen index position eliminating the wasted time of performing zero return.

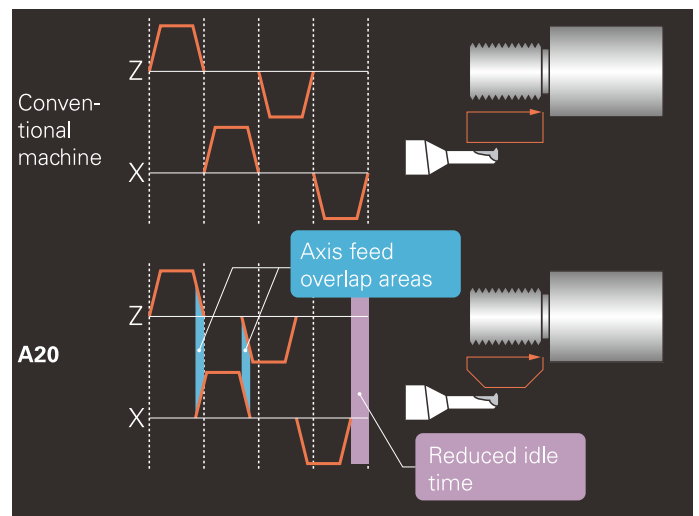

Axis feed overlap function
The next axis feed motion starts without waiting for completion of the current motion of another axis. This cuts out wasteful idle time and also suppresses unwanted vibration.

Machine Layout

A20 Standard Machine

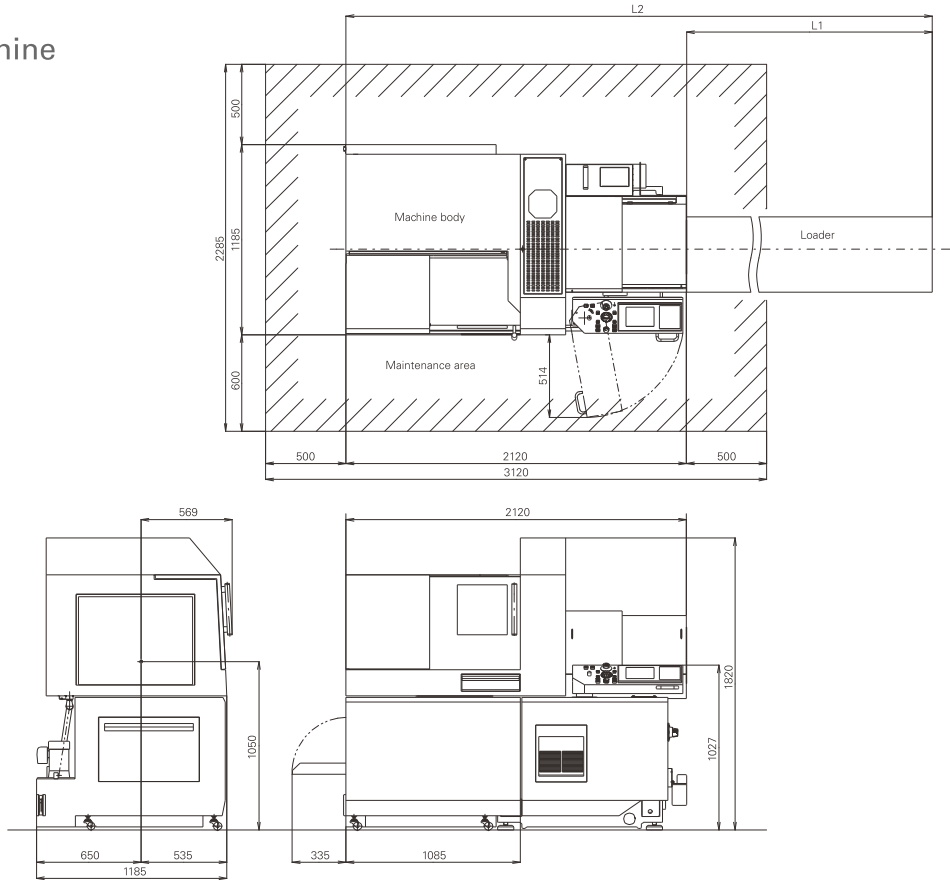

A20 Option-installed Machine

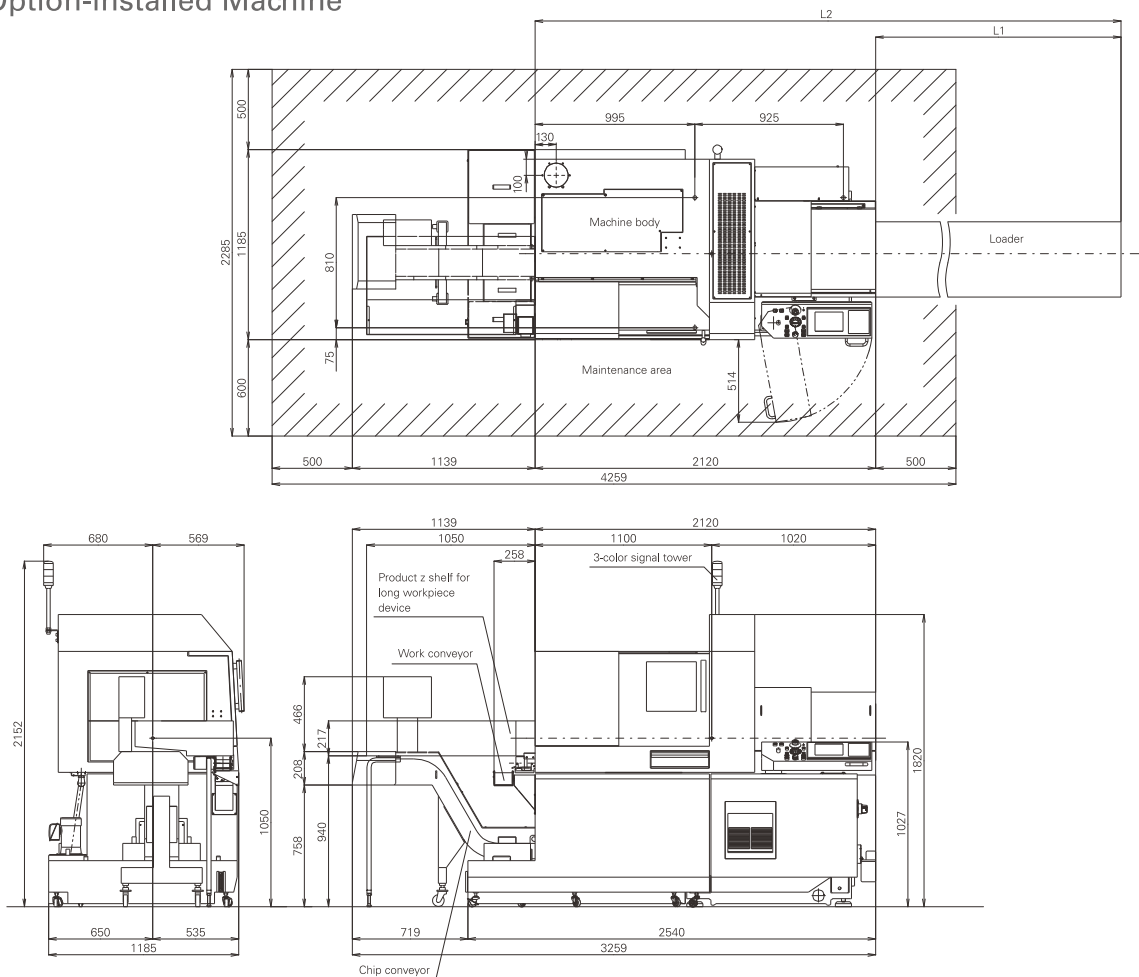

Machine Specification

Item	A20 VII (A20-3F7)
Max. machining diameter (D)	20 mm Dia. (25 mm Dia. ^{OP})
Max. machining length (L)	GB:200mm/1 chucking(188mm/25mm Dia. spec.) GBL:2.5D
Max. front drilling diameter	10 mm Dia.
Max. front tapping diameter (tap, die)	M8
Spindle through-hole diameter	26 mm Dia.
Main spindle speed	Max.10,000min ⁻¹
Max. drilling diameter for the gang rotary tool	7mm Dia.
Max. tapping diameter for the gang rotary tool	M6
Spindle speed of the gang rotary tool	Max.6,000 min ⁻¹ (Rating 4,500 min ⁻¹)
Max. chuck diameter of back spindle	20 mm Dia. (25 mm Dia. ^{OP})
Max. protrusion length of the back spindle workpiece	50 mm
Max. drilling diameter in back machining process	8 mm Dia.
Max. tapping diameter in back machining process	M6
Back spindle speed	Max.8,000 min ⁻¹
Max. protrusion length	100 mm
Number of tools to be mounted	21
Tool size	
Tool (gang tool post)	12 mm Sq.×120 mm (13mm Sq. ^{OP})
Sleeve	25.4 mm Sq.
Chuck and bushing	
Main spindle collet chuck	FC034-M, FC071-M
Back spindle collet chuck	FC034-M-K, FC071-M-K
Rotary tool collet chuck	ER11, ER16
Chuck for drill sleeves	ER11, ER16
Guide bushing	FG206-M / FG521-M
Rapid feed rate	
All axes (except X1)	32 m/ min
X1 axis	18 m/ min
Motors	
Spindle drive	2.2/ 3.7 kW
Tool spindle drive	0.75 kW
Back spindle drive	1.1/ 1.5 kW
Coolant oil	0.4 kW
Lubricating oil	0.003 kW
Center height	1,050 mm
Rated power consumption	7.1 kVA
Full load current	20.2 A
Main breaker capacity	30 A
Air pressure and air flow rate for pneumatic devices	0.5 M pa, 47 NL
Weight	2,200 kg

Standard accessories

Main spindle chucking device	Coolant unit (with level detector)
Back spindle chucking device	Lubricating oil supply unit (with level detector)
Cut-off tool breakage detection	Door lock
Work light (LED)	Pneumatic device for air sealing
Workpiece separator	Machine relocation detector

Special accessories

Rotary guide bushing device	Chip conveyor
Fixed guide bus	Medium-pressure coolant unit
Knock-out jig for through-hole workpiece	Coolant flow rate detector
Callback chute	Signal lamp
Product receiver shelf for long workpiece device	3-color signal tower
Workpiece conveyor	LFV

Standard NC functions

NC unit dedicated to the A20	
8.4 inch color LCD	Program storage capacity : 40m(approx.16KB)
On-machine program check function	Tool offset pairs : 32
Operating time display function	Product counter indication (up to 8 digits)
Preparation function	Main spindle indexing at 15° intervals
Spindle speed change detector	Automatic power-off function
Nose radius compensation	Continuous thread cutting function
Constant surface speed control function	Program prior analysis function

Special NC functions

Program storage capacity 2560m (approx.1MB)	
Tool offset pairs : 49	Hob/polygon function B
Submicron commands	Spindle 1°indexing function
Spindle synchronized function	Back spindle 1°indexing function
Rigid tapping function	Front/Back spindle C-axis function
High speed rigid tapping function	Tool life management I
Chamfering, corner R	Tool life management II
Canned cycle drilling	Optional block skip (9 sets)
Drawing dimension direct input	External memory program driving
Multiple repetitive cycle for turning	Network I/O function
User macros	Inch command
Yaxis offset	Sub/inch Command

CITIZEN MACHINERY CO., LTD.

CITIZEN

JAPAN	CITIZEN MACHINERY CO.,LTD. 4107-6 Miyota, Miyota-machi, Kitasaku-gun, Nagano-ken, 389-0206, JAPAN	TEL.81-267-32-5901	FAX.81-267-32-5908
SOUTH ASIA / KOREA	CITIZEN MACHINERY CO.,LTD. 4107-6 Miyota, Miyota-machi, Kitasaku-gun, Nagano-ken, 389-0206, JAPAN	TEL.81-267-32-5901	FAX.81-267-32-5908
TAIWAN	CINCOM MIYANO TAIWAN CO.,LTD. 10FL, No.174, Fuh Sing N. Rd., Taipei, TAIWAN	TEL.886-2-2715-0598	FAX.886-2-2718-3133
CHINA	CITIZEN (CHINA) PRECISION MACHINERY CO.,LTD. 10058, XINHUA ROAD OF ZHOUCUN, ZIBO, SHANDONG, P.R. CHINA	TEL.86-533-6150560	FAX.86-533-6161379
EUROPE-Germany	CITIZEN MACHINERY EUROPE GmbH Mettinger Strasse 11, D-73728 Esslingen, GERMANY	TEL.49-711-3906-100	FAX.49-711-3906-106
EUROPE-UK	CITIZEN MACHINERY UK LTD 1 Park Avenue, Bushey, WD23 2DA, UK	TEL.44-1923-691500	FAX.44-1923-691599
EUROPE-Italia	CITIZEN MACCHINE ITALIA s.r.l. Via Guglielmo Marconi 47 24040 Comun Nuovo (BG), ITALY	TEL.39-035-877738	FAX.39-035-876547
AMERICA	MARUBENI CITIZEN-CINCOM INC. 40 Boroline Road Allendale, NJ 07401, U.S.A.	TEL.1-201-818-0100	FAX.1-201-818-1877

URL:<https://cmj.citizen.co.jp/>

All specifications are subject to change without prior notice. This product is an export control item subject to the foreign exchange and foreign trade act. Thus, before exporting this product, or taking it overseas, contact your CITIZEN machine dealer. Please inform your CITIZEN machine dealer in advance of your intention to re-sell, export or relocate this product. For the avoidance of doubt products includes whole or part, replica or copy, technologies and software. In the event of export, proof of approval to export by government or regulatory authority must be evidenced to CITIZEN. You can operate the machines after the confirmation of CITIZEN. CITIZEN, LFV, MultiStationMachiningCell and Ocean technology is a registered trademark of Citizen Watch Co., Japan.

PRINTED IN JAPAN FEB. 2019