

CITIZEN

Cincom

L32

Sliding Headstock Type CNC Automatic Lathe



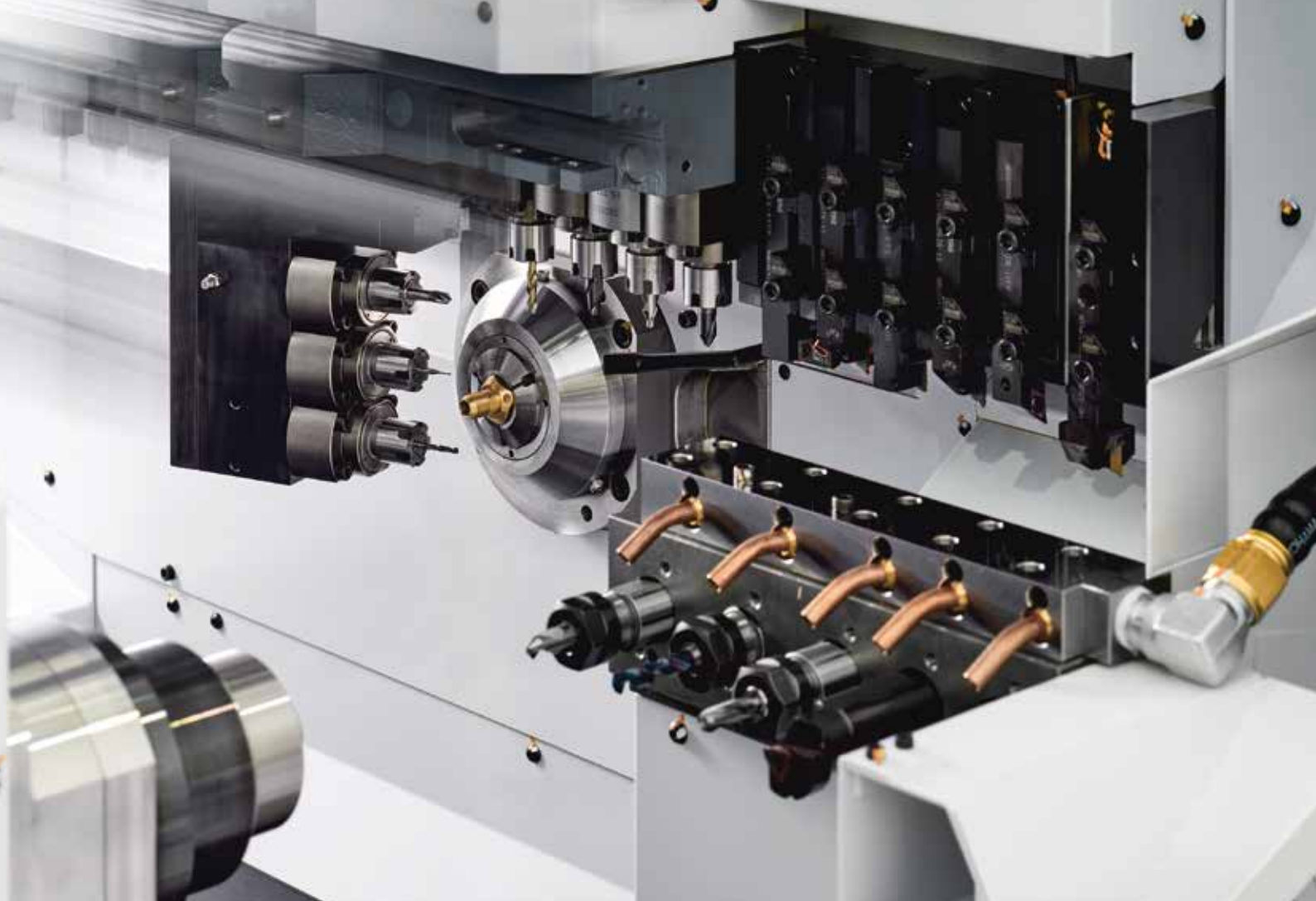

Cincom's Time-tested L Series Adopts Modular Design

A best-selling machine with a legacy at Cincom, the L32, has seen the launch of 4 new models with a modular design. With a range from a 5-axis machine with excellent cost performance to a high-end machine equipped with B axis and back tool post Y axis, you can select the machine according to the functions you require.

And in combination with the wide range of tooling, these machines can cope flexibly with the workpieces to be machined.





L32 XII

Basic Construction

	Type	VIII	IX	X	XII
B axis (rotary tools on the gang tool post)		N/A	Std.	N/A	Std.
Y2 axis (back tool post Y axis)		N/A	N/A	Std.	Std.
Rotary tools on the opposite tool post	OP	OP	OP	OP	OP
Rotary tools on the back tool post	OP	OP	Std.	Std.	

Back tool post rotary tools Optional for Type VIII/IX

6,000 min⁻¹ (Max.)
3,000 min⁻¹ (rating)
Motor : 1.0 kW

Front spindle

8,000 min⁻¹
Motor : 3.7/ 7.5kW
Max. machining length : 320 mm/ 1chucking (GB)

Rotary tools on the gang tool post

6,000 min⁻¹ (Max.)
4,500 min⁻¹ (rating)
Motor : 1.0 kW

Rotary tools on the opposite tool post *optional

6,000 min⁻¹ (Max.)
3,000 min⁻¹ (rating)
Motor : 1.0 kW

Back spindle

8,000 min⁻¹
Motor : 2.2/ 3.7 kW

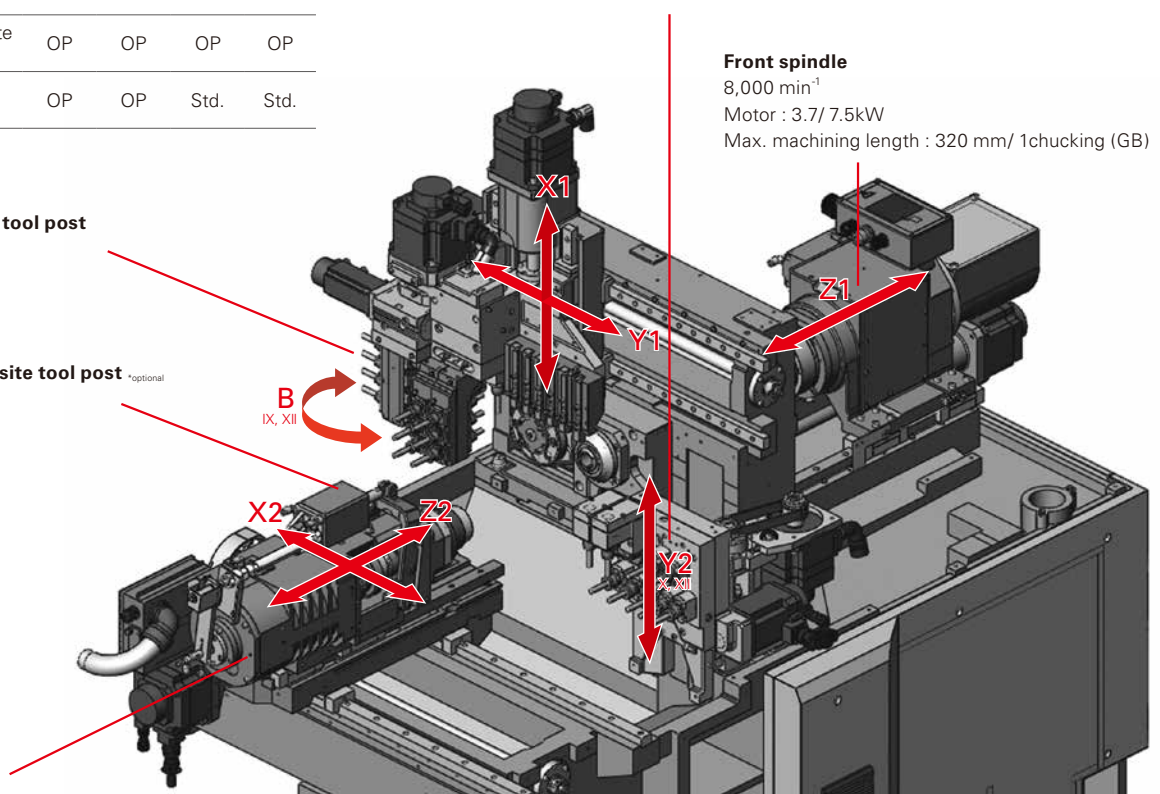

Function Modules that can be Combined without Restrictions

With a modular design, the L32 has a lineup of four Types – VIII, IX, X and XII – which can be combined with selected variations: rotary tools on a gang tool post, an opposite tool post, or a back tool post.



U32B (Rotary tool on the gang tool post B axis)



U121B (Rotary tool on the opposite tool post)



U12B (Back tool post incorporating Y axis)

We allow selection of functions according to the machining needs, and help customers optimize their manufacturing by combining these functions to achieve their ideal machine configuration.

Ability to switch between guide bushing type and guide bushing-less type

The guide bushing can be fitted and removed in a quick and simple operation. The machine can be used as an automatic lathe with two roles in a single machine: as a regular guide bushing type automatic lathe when machining long thin workpieces, and as a guide bushing-less automatic lathe when using cold drawn material and to leave short remnant bars.



Guide bushing-less type



Guide bushing type

Optional support for stock up to 38 mm Dia.

There is optional support for supply of 38 mm Dia. stock. The maximum machining length per chucking is the same as the standard specifications at 320 mm. A wide range of workpieces can be machined.

Workpiece conveyor equipped as standard

A workpiece conveyor is equipped as standard to facilitate the efficient mass production of large-diameter workpieces. The cover over the unloading route can be removed easily, giving good maintainability too.

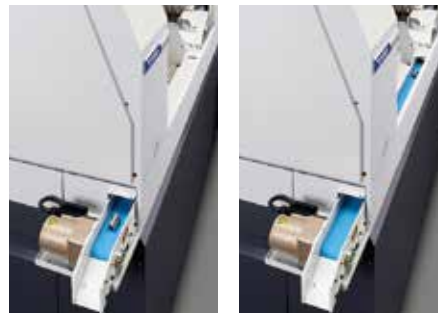

LFV Technology (optional)



LFV* is a technology for performing machining while vibrating the X and Z servo axes in the cutting direction in synchrony with the rotation of the spindle. It reduces various problems caused by chips entangling with the product or tool, and is effective for small-diameter deep hole machining and the machining of difficult-to-cut materials.

*LFV is a registered trademark of Citizen Watch Co., Ltd.

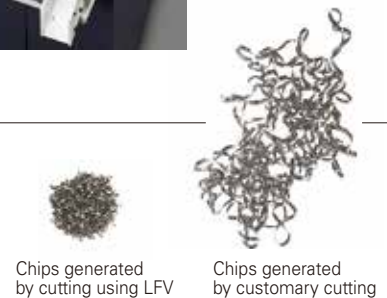

Chips generated by cutting using LFV

Chips generated by customary cutting

LFV mode 1

Ideal for outer/inner diameter machining and groove machining

Multiple vibrations per spindle revolution



LFV mode 2

Ideal for micro-drilling, where peripheral speed is required

Multiple spindle revolutions per vibration



LFV mode 3

Optimal for threading of internal and external diameters

Vibration threading



Note 1: LFV machining cannot be performed with the Y axis. Note 2: LFV machining can be performed simultaneously on a maximum of 2 pair of axes. Note 3: For LFV machining with rotary tools, the "LFV function" and "rotary tool feed per revolution" options are required. Note 4: LFV1/LFV2 and LFV3 are separate options. Cannot purchase only LFV3.

ATC (Automatic Tool Changer) L32XII dedicated option

The B-axis ATC (automatic tool changer), acclaimed with the L20, is now available as an option for the L32.

Citizen's unique, compactly designed B-axis ATC tooling can be mounted on the gang tool post to enable use of a total of 13 B-axis tools, comprising 12 ATC tools for front machining and one tool built into the tooling.

- In addition to the capability for machining complex parts like medical parts, the ATC unit/tooling provides an environment where the tool setting for machining several types of workpieces can be completed in a single setup.
- In addition to B-axis machining, the ATC tooling can also be used in a wide range of applications such as those with cross machining/end face hole machining and slitting/hobbing, utilizing a wealth of tool variations.
- A 2.2 kW motor is used for the gang tool spindle. This gives rotary tools high torque and high speed performance.
- The tool pitch of B-axis ATC tooling is compatible with 38 mm diameter bar stock. It provides a wide range of milling capabilities.



During B-axis machining



Magazine



During B-axis tool change



ATC tools

Tool presetter

Specification

Maximum rotary tool speed on ATC tooling	12,000 min ⁻¹
Motor output	2.2 kW
Tool holder type	JBS-15T
Number of B-axis tools	12(magazine) + 1 (built-in)

Total number of tools mountable on machine	34 maximum (including B-axis tools)
Tool change time (chip-to-chip)	4 sec
Maximum tool outer diameter	30 mm Dia.
Maximum tool gripping diameter	10 mm Dia. (ER16)

Remnant Bar Reducing Function VIII,IX,X,XII Option

This new function reduces the "unmachinable material that had to be left" constituting an issue for many years with sliding headstock type automatic lathes. It is original technology from Citizen that makes it possible to join a remnant bar to a new bar by "friction joining" and machine it in the same way as a new bar. By firmly clamping the material, optimal joining pressure is applied to avoid slippage during friction joining and achieve good joining quality. Remnant bars can be reduced to about one fifth of the conventional 200 mm to 300 mm. Utilizing material to the maximum extent greatly helps to reduce environmental impact and reduce costs in machining, particularly of high added value materials.



Clamping device specifications

Applicable models	L32-1M8, L32-1M9, L32-1M10, L32-1M12
Maximum joining diameter	25 mm dia.
Maximum joinable remnant bar length	300 mm
Chuck type	FC925-M
Maximum chuck thrust resistance	10kN
Mounted position	T23 (opposite tool post)

Remnant Bar Reduction Effect (Trial Calculation)

Item	Case 1		Case 2	
	Standard Specification Machine	Remnant Bar Reducing Function	Standard Specification Machine	Remnant Bar Reducing Function
Model	L32			
Bar length (mm)	2,500		2,000	
Bar diameter (mm)	20		16	
Workpiece length (mm)	100		120	
Cut-off tool width (mm)	2.0		2.0	
Cycle time (seconds)	90.0		120.0	
Bar change time (seconds)	60.0	180.0(+120)	60.0	180.0(+120)
Number of machinable workpieces (per bar)	22	24 (+2, +9.1%)	14	16 (+2, +14.3%)
Remnant bar length (mm)	256	52 (-204mm, -79.7%)	292	48 (-244mm, -83.6%)
Production count (products/month)	15,000	15,000	10,000	10,000
Number of bars (per month)	682	625(-57, -8.4%)	715	625(-90, -12.5%)

Comparison length of remnant

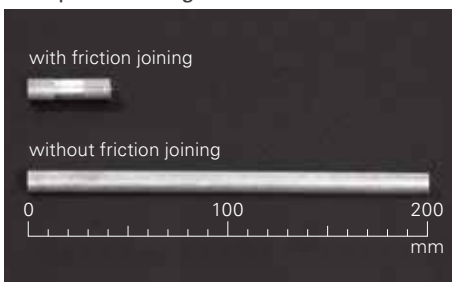

*This data is based on a trial calculation and reduction effect of remaining bar material depends on the condition, which is not guaranteed.

Tooling area

VIII, IX

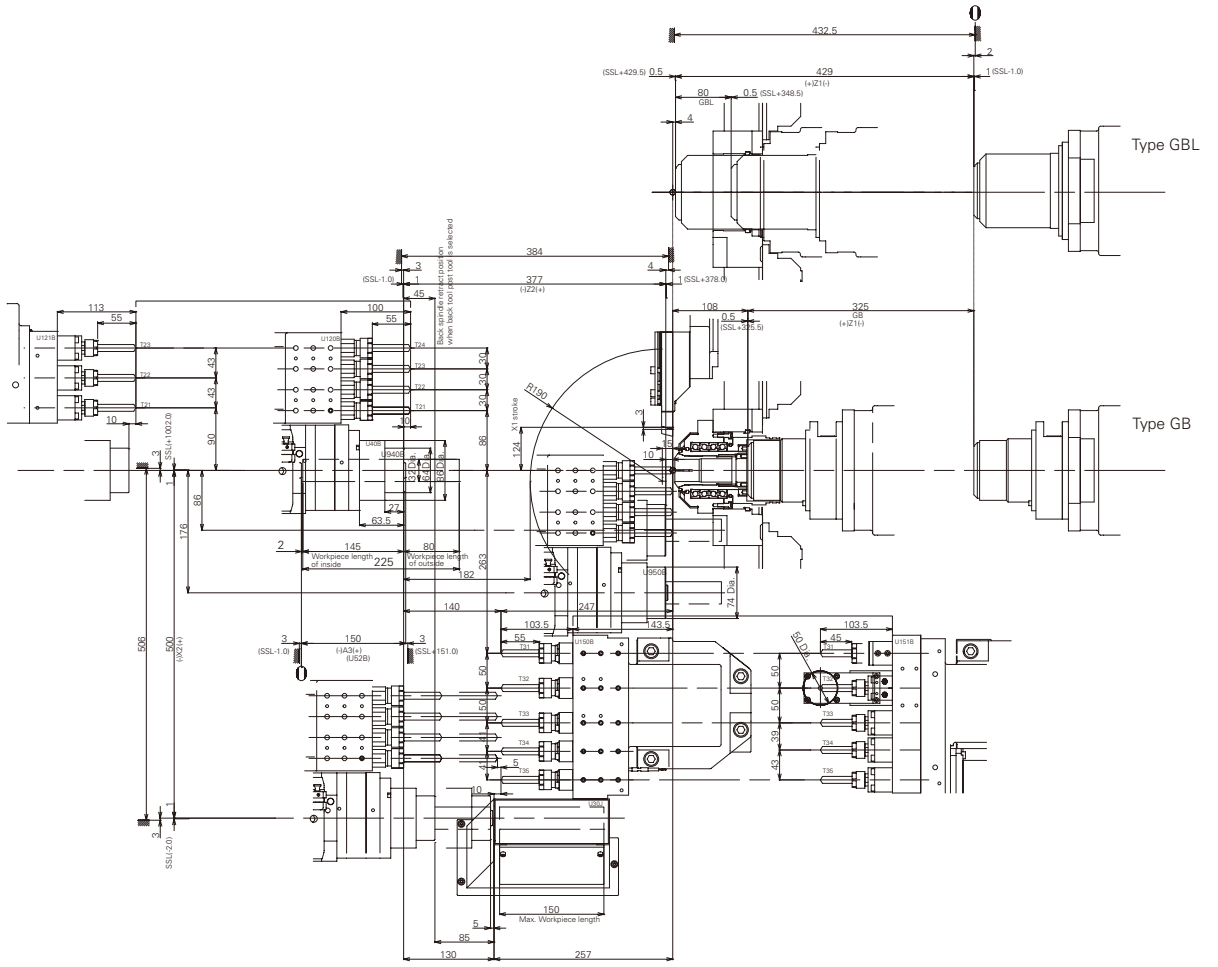

X, XII, XII ATC

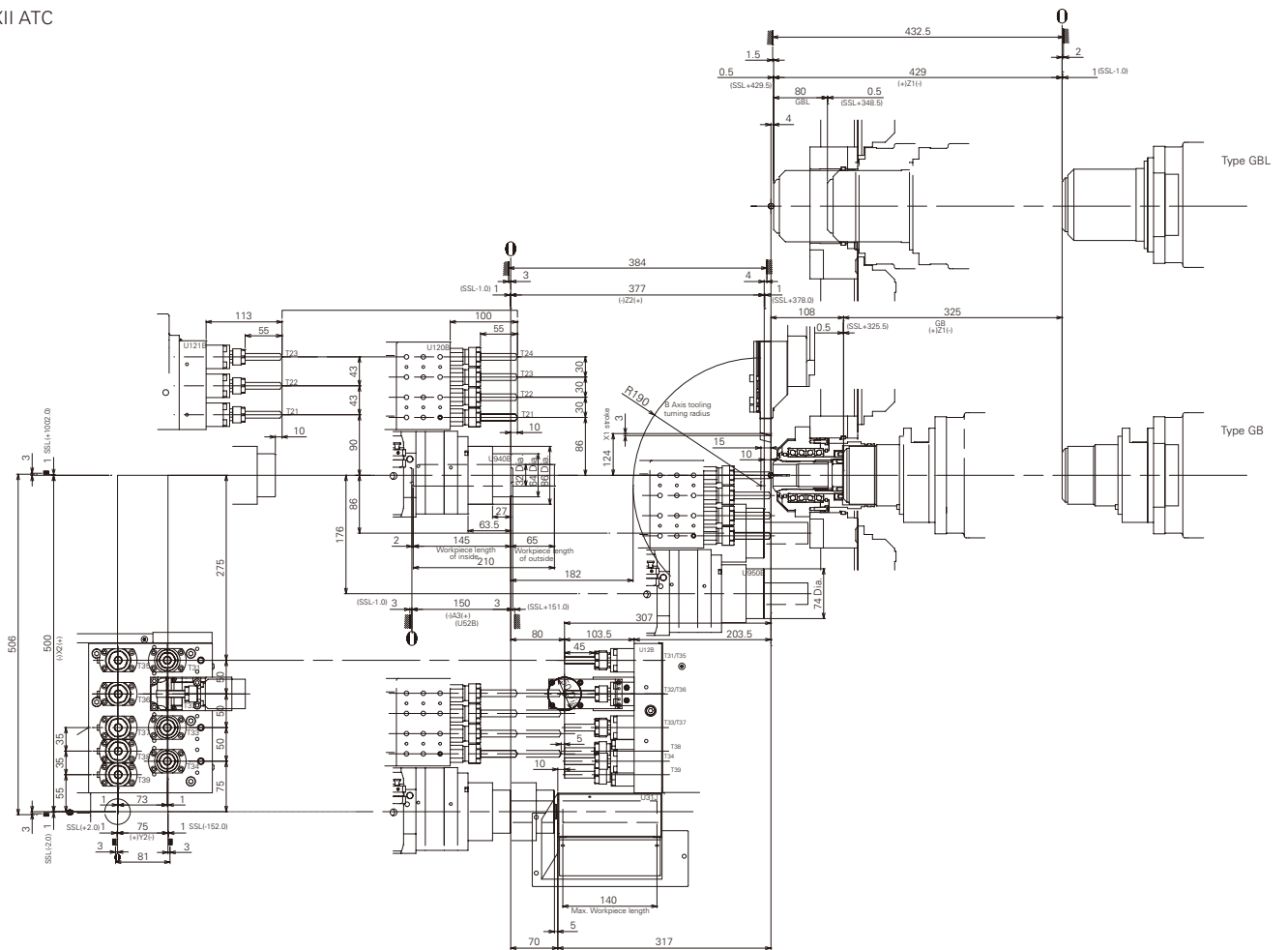

External view

VIII, IX, X, XII

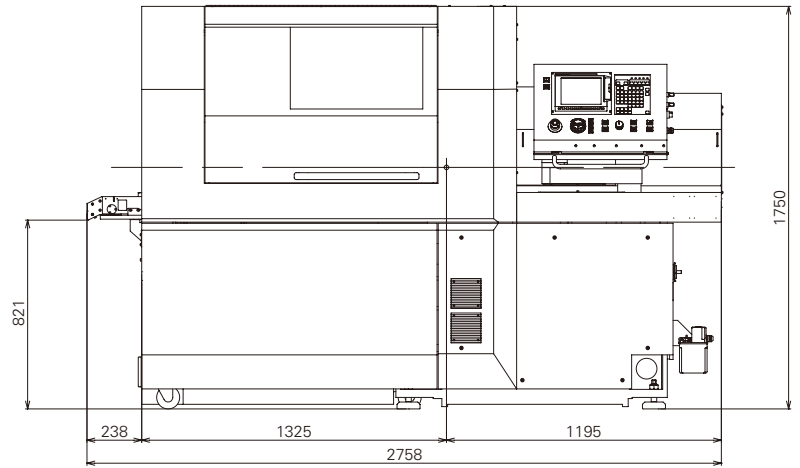
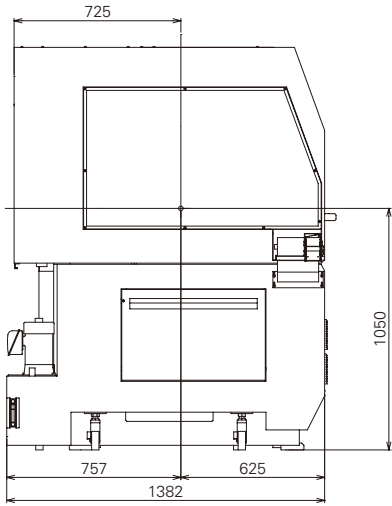

XII ATC

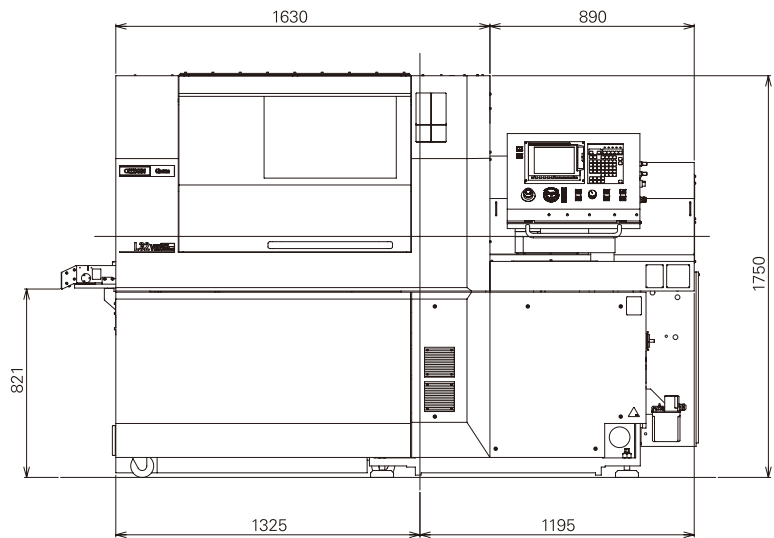
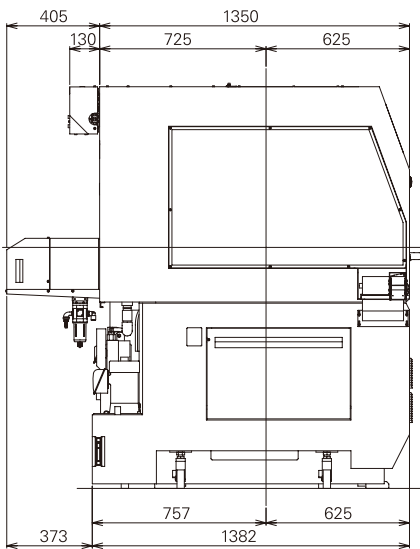
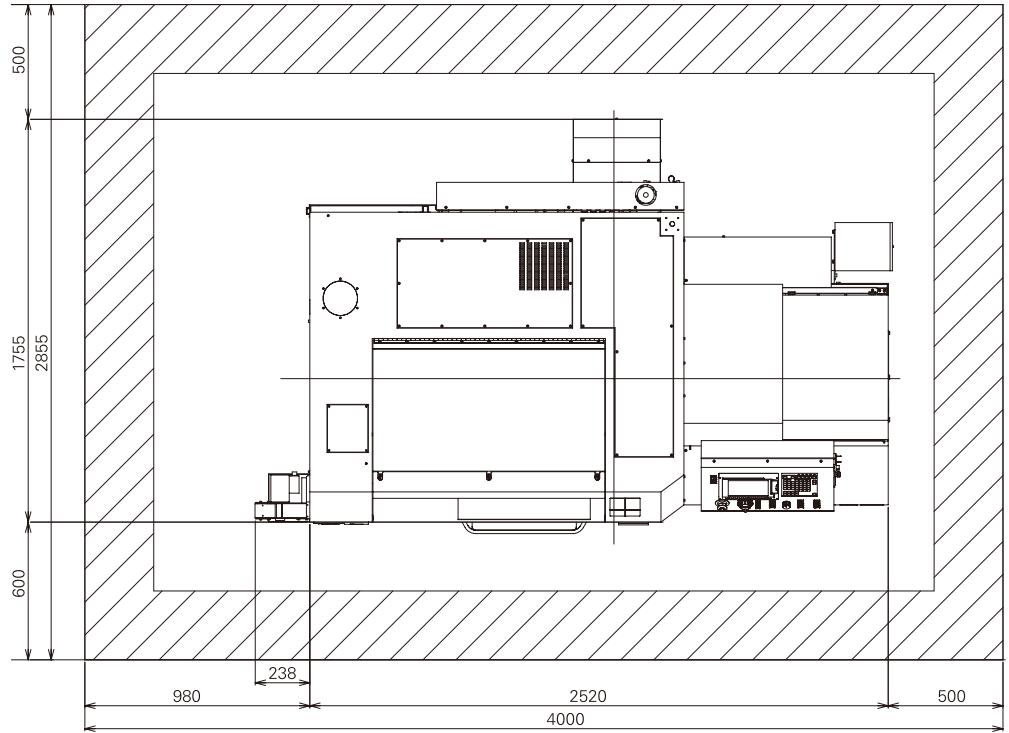

Machine Specification

Item	L32			
	VIII	IX	X	XII
	L32 - 1M8	L32 - 1M9	L32 - 1M10	L32 - 1M12
Max. machining diameter (D)	32 mm Dia. (38 mm Dia. Option)			
Max. machining length (L)	GB: 320 mm/ 1chucking, GBL: 2.5D			
Max. front drilling diameter	12 mm Dia.			
Max. front tapping diameter	M12			
Spindle through-hole diameter	39 mm Dia.			
Main spindle speed	Max. 8,000 min ⁻¹			
Max. chuck diameter of the back spindle	32 mm Dia.			
Max. protrusion length of the back spindle workpiece	80 mm	65 mm		
Max. protrusion length	150 mm	140 mm		
Max. drilling diameter for the back spindle	10 mm Dia.			
Max. tapping diameter for the back spindle	M10			
Back spindle speed	Max. 8,000 min ⁻¹			
Gang rotary tool				
Max. drilling diameter	10 mm Dia.			
Max. tapping diameter	M8			
Spindle speed	Max. 6,000 min ⁻¹ Rating: 4,500min ⁻¹			
Back tool post rotary tool ^{*1}				
Max. drilling diameter	8 mm Dia.			
Max. tapping diameter	M6			
Spindle speed	Max. 6,000 min ⁻¹ Rating: 3,000 min ⁻¹			
Front rotary tool ^{*2}				
Max. drilling diameter	8 mm Dia.			
Max. tapping diameter	M6			
Spindle speed	Max. 6,000 min ⁻¹ (Rating: 3,000 min ⁻¹)			
Number of tools to be mounted max	19 - 30	26 - 36	24 - 44	30 - 40
Gang turning tool	6	6	6	6
Gang rotary tool	4 - 6	7 - 11	5 - 13	7 - 11
Front drilling tool	4 - 9	4 - 14	4 - 16	4 - 9
Back drilling tool	5 - 11	9 - 15	9 - 20	13 - 19
Tool size				
Gang turning tool	16 mm SQ×130 mm			
Sleeve	25.4 mm Dia.			
Chuck and bushing				
Main spindle collet chuck	FC081-M (FC251-M: 38 mm Dia. spec.)			
Back spindle collet chuck	FC081-M (FC251-M: 38 mm Dia. spec.)			
Rotary tool collet chuck	ER11, ER16			
Chuck for drill sleeves	ER11, ER16			
Guide bushing	FG531-M (FG581-M: 38 mm Dia. spec.)			
Rapid feed rate				
All axes (except Y2)	32 m/ min			
Y2 axis	---			24 m/ min
Motors				
Spindle drive	3.7/ 7.5 kW			
Gang tool post rotary tool drive	1.0 kW (2.2kW when U74T attached)			
Back spindle drive	2.2/ 3.7 kW			
Back tool post rotary tool drive ^{*1}	1.0 kW			
Front rotary tool drive ^{*2}	1.0 kW			
Coolant oil	0.4 kW			
Lubricating oil	0.003 kW			
Center height	1,050 mm			
Rated power consumption	13.2 kVA			
Load operation average power	6.9 kVA			
Full-load current	68 A (73A when U74T attached)			
Main breaker capacity	100 A			
Air pressure and air flow rate for pneumatic devices	0.5 MPa 64.2 NL/ min			
Weight	2,850 kg	2,900 kg		

*1 Type VIII, Type IX back tool post rotary tool is optional *2 Front rotary tool drive unit is optional

Standard accessories

Main spindle chucking unit	Back spindle chucking unit
Gang rotary tool driving unit	Coolant unit (with level detector)
Lubricating oil supply unit (with level detector)	Machine relocation detector
Door lock	Cut-off tool breakage detector
Work conveyor	Lighting
Rotary guide bushing drive unit	Main spindle coolant unit
Back tool post rotary unit ^{*Type X,XII}	Automatic fire extinguisher

Special accessories

Rotary guide bushing unit	Knock-out jig for through-hole workpiece
Chip conveyor	Medium-pressure coolant unit
Coolant flow rate detector	Back rotary tool unit ^{*Type VIII,IX}
Signal lamp	3-color signal tower
Back tool post rotary tool drive device	ATC
Remnant Bar Reducing Function ^{*Type VIII, IX, X, XII}	

Standard NC functions

CINCOM SYSTEM M70LPC-2AVU (Mitsubishi)	8.4 inch color LCD
USB slot	Program storage capacity: 40m (approx. 16GB)
Tool offset pairs: 40	Product counter indication (up to 8 digits)
Operating time display function	Machine operation information display
B axis control function ^{*Type IX,XII}	Back spindle chasing function
Synch tapping phasing function	Interference check function
Spindle speed change detector	Spindle speed change detector
Automatic power-off function	Main spindle indexing at 1° intervals
On-machine program check function	Nose radius compensation
Eco indication	

Special NC functions

Variable lead thread cutting	Arc threading function
Chamfering, corner R	Geometric function
Multiple repetitive cycle for turning	Spindle synchronized function
Spindle C-axis function	Milling interpolation
Back spindle 1° indexing function	Back spindle C-axis function
Canned cycle drilling	Rigid tapping function
High speed Rigid tapping function	Differential speed rotary tool function
Optional block skip (9 sets)	Tool offset pairs: 80
Back machining program skip function	Tool life management I
Tool life management II	Program storage capacity 600m (approx. 240GB)
External memory program driving	Submicron commands
User macros	Helical interpolation function
Slant helical interpolation function	Hob function
Polygon function	Inch command
Sub inch command	Network I/ O function
LFV mode1, mode2	LFV mode3

*1 This is the power consumption when the machine is operation at full capacity.

*2 This is the standard power consumption during machine operation.

*3 This is the power consumption varies depending on the cutting conditions and other conditions.

*4 This is the standby power in the idle stop mode (a function that turns servomotor excitation off when it is not necessary, for example during program editing).

*5 This is the power consumption in program operation (when not cutting) for one of our standard test pieces, shown for the purpose of comparing the environmental performance with that of existing models.

*6 This is the average cycle time is 55 sec with the standard test workpiece of our company.

*7 This is the value converted in accordance with the CHUBU Electric Power CO2 emissions coefficient for 2009 as published by the Ministry of the Environment.

*8 If polyvinyl chloride (PVC) and fluorine resin are not processed correctly they can generate harmful gases. When recycling these materials, commission a contractor that is capable of processing them appropriately.

Environmental Information

Basic Information	Energy usage	Power supply voltage	AC 200 V
		Rated power consumption ^{*1}	13.2 kVA
		Load operation average power ^{*2}	6.9 kVA
		Required pneumatic pressure	0.5 MPa
		Standby power ^{*3}	0.320 kW
Environmental Performance Information	Power consumption	Power consumption with model workpiece ^{*4,5}	0.0133 kWh/ cycle
		Power consumption value above converted to a CO ₂ value ^{*6}	6.3 g/ cycle
		Air consumption	45 NL/ min (power ON), 64.2 NL/ min (stationary), 182 NL/ min (air blow)
		Lubricant consumption	At power ON
		Noise level	2.5 cc/ 60min
Approach to Environmental Issues	Recycling	Value measured based on JIS	78.5 dB
		Indication of the material names of plastic parts	Covered in the instruction manual ^{*7}
		Environmental management	We are ISO14001 accredited. We pursue "Green Procurement", whereby we make our purchases while prioritizing goods and services that show consideration for the environment.

CITIZEN MACHINERY CO., LTD.

CITIZEN

JAPAN	CITIZEN MACHINERY CO., LTD. 4107-6 Miyota, Miyota-machi, Kitasaku-gun, Nagano-ken, 389-0606, JAPAN	TEL.81-267-32-5901
SOUTH ASIA/ KOREA	CITIZEN MACHINERY CO., LTD. 4107-6 Miyota, Miyota-machi, Kitasaku-gun, Nagano-ken, 389-0606, JAPAN	TEL.81-267-32-5961
ASEAN	CITIZEN MACHINERY ASIA CO., LTD. 199, Mu 1, Phahon Yothin Road, Sanap Tuep Sub-district, Wang Noi District, Phra Nakhon Si Ayutthaya Province 13170,Thailand	TEL.66-35-90-2640
TAIWAN	CINCOM MIYANO TAIWAN CO., LTD 10FL, No. 174, Fuh Sing N. Rd., Taipei, TAIWAN, R.O.C.	TEL.886-2-2715-0598
CHINA	CITIZEN (CHINA) PRECISION MACHINERY CO., LTD. 3010.SICHOU ROAD OF ZHOUCUN, ZIBO, SHANDONG, P.R.CHINA	TEL.86-533-6150560
GERMANY	CITIZEN MACHINERY EUROPE GmbH. Mettinger Strasse 11, D-73728 Esslingen GERMANY	TEL.49-711-3906-100
UK	CITIZEN MACHINERY UK Ltd. 1 Park Avenue, Bushey, WD23 2DA, UK	TEL.44-1923-691500
ITALIA	CITIZEN MACCHINE ITALIA s.r.l. Via Guglielmo Marconi 47 - 24040 Cornun Nuovo (BG), ITALY	TEL.39-035-877738
FRANCE	HESTIKA FRANCE S.A.S. 1385 Avenue du Môle Z.A.E des Lacs 3, 74130 AYZE, FRANCE	TEL.33-4-5098-5269
SPAIN	EGASCA, S.A. Poligono Industrial Erisono 2, 20600 Eibar (Gipuzkoa), SPAIN	TEL.34-943-200300
AMERICA	MARUBENI CITIZEN-CINCOM INC. Headquarters(NJ) 40 Boroline Road Allendale, NJ 07401 U.S.A.	TEL.1-201-818-0100

URL: <https://cmj.citizen.co.jp/>

All specifications are subject to change without prior notice. This product is an export control item subject to the foreign exchange and foreign trade act. Thus, before exporting this product, or taking it overseas, contact your CITIZEN machine dealer. Please inform your CITIZEN machine dealer in advance of your intention to re-sell, export or relocate this product. For the avoidance of doubt products includes whole or part, replica or copy, technologies and software. In the event of export, proof of approval to export by government or regulatory authority must be evidenced to CITIZEN. You can operate the machines after the confirmation of CITIZEN. CITIZEN, Cincom, Miyano, LfV and MultiStationMachiningCell is a registered trademark of Citizen Watch Co., Japan.